

# 九宏五金

雙人立式櫥櫃側掀床 加書桌

安裝說明書



1. 櫃體四邊厚18mm也可。

2. 踢腳板高10cm也適用。

Ps. 餘尺寸亦可安裝，置位需自行運算。

此份為最新掀床說明書！共10張  
客戶簽收：

# 物美雙人側掀床五金尺寸

## 物美雙人側掀床五金尺寸+書桌

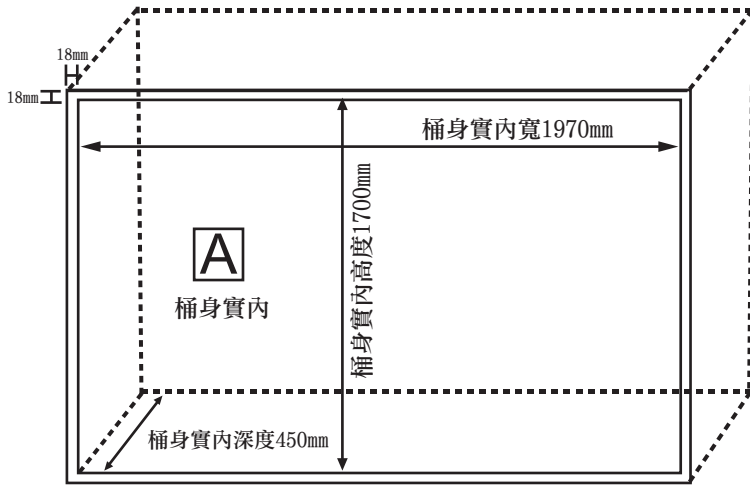

桶身實內

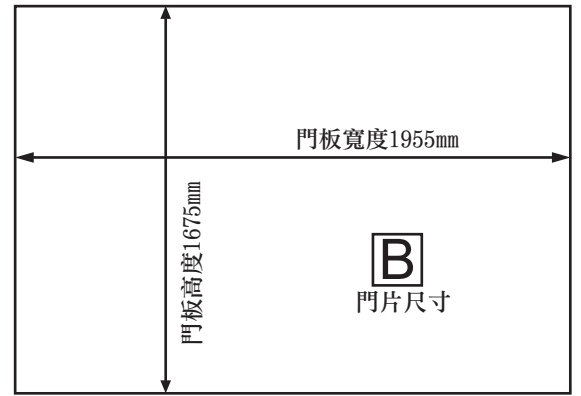

床架門板

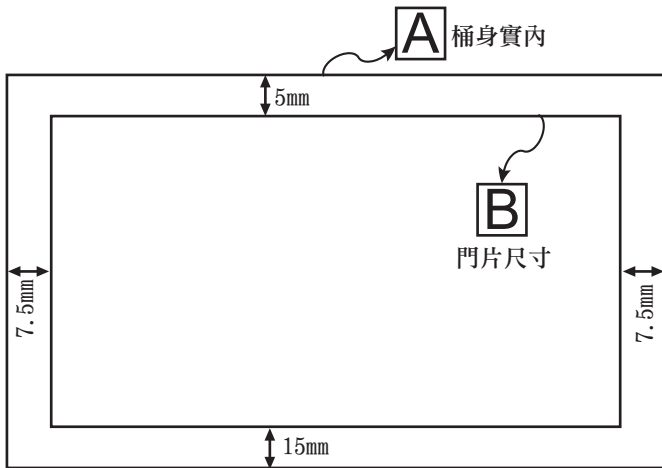

桶身與門板的縫隙

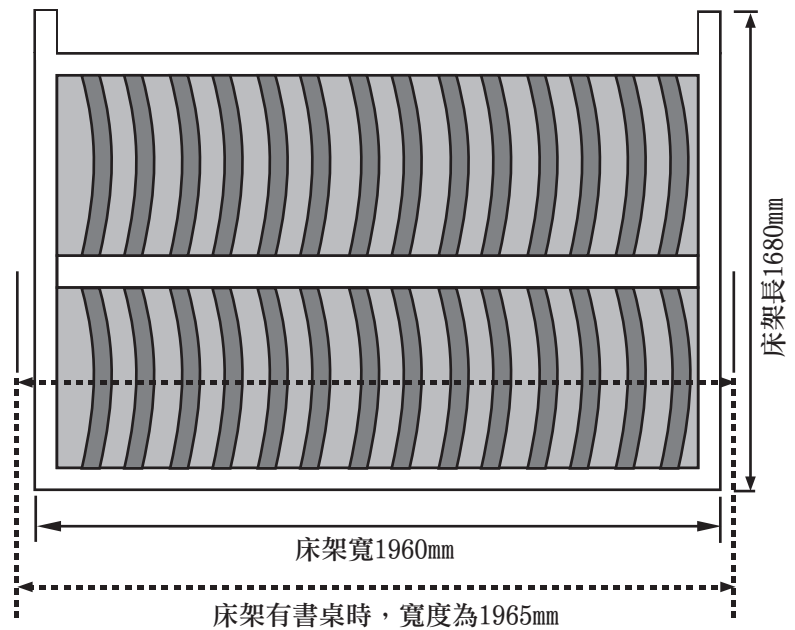

床墊尺寸: 1545 (5尺) X 1900 (6.2尺)

床墊重量 (無桌板): 35KG <sup>+0kg</sup> <sub>-1kg</sub>

床墊重量 (有桌板): 27KG <sup>+0kg</sup> <sub>-1kg</sub>

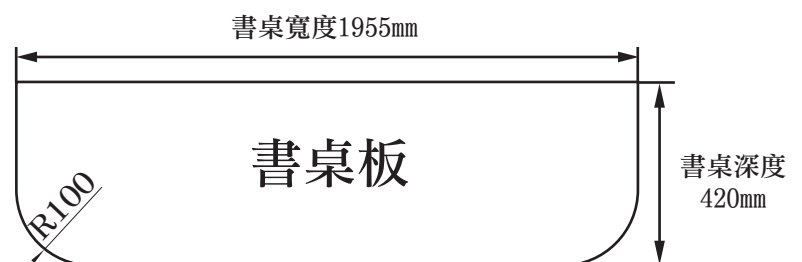
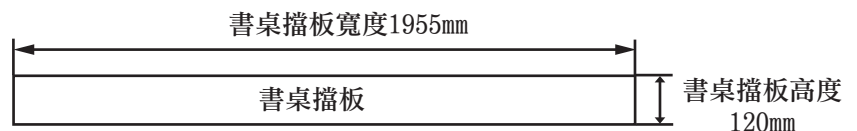

# 依客戶需求二擇一安裝床墊擋

## 側掀雙人 床墊擋板

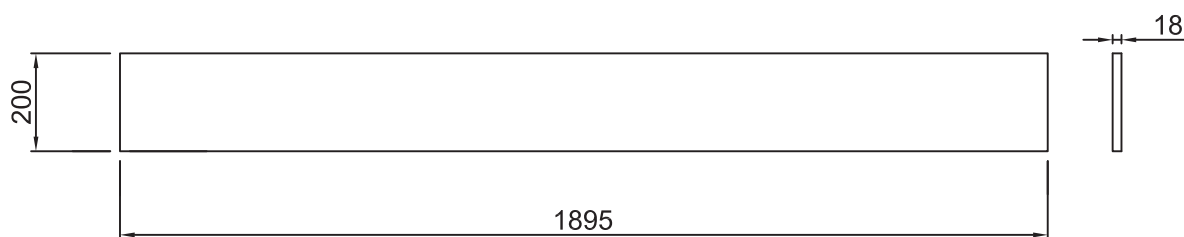
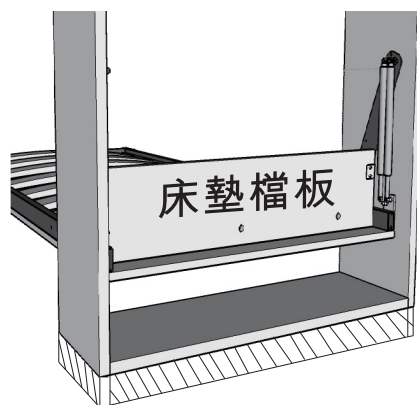

## 床墊擋把手 (亦可用)

鎖至床架上 (使用自攻螺絲)

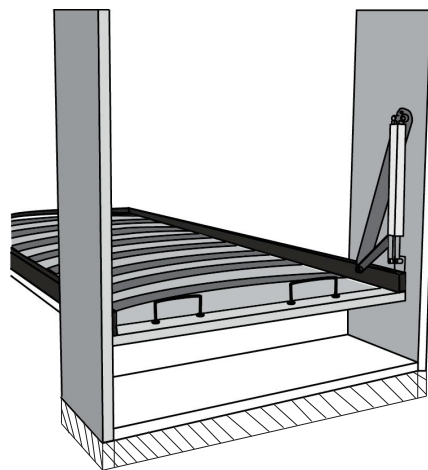

# 雙人立式櫥櫃側掀床 加書桌

## 安裝說明

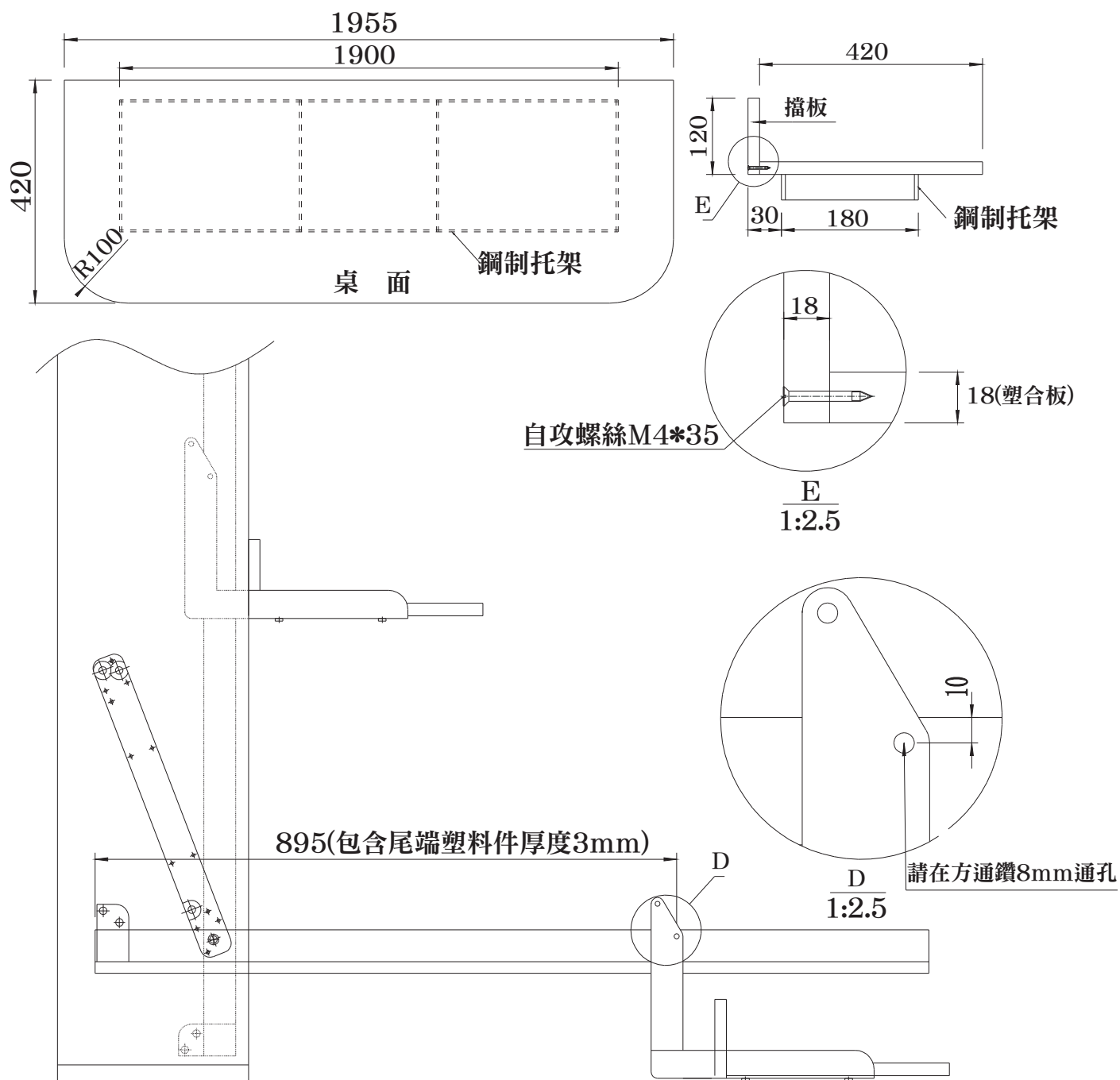



1

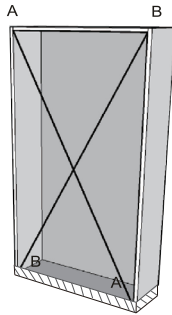

### 櫃體安裝

保證櫃體對角線A-A和B-B相等

2

**非常重要**

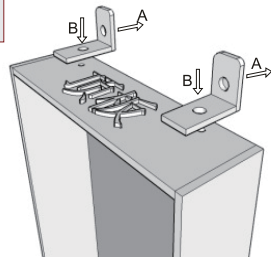

### 櫃體固定

用膨脹螺絲和L片將櫃體固定在牆上  
如圖：A向膨脹螺絲 B向M8X40螺絲

3

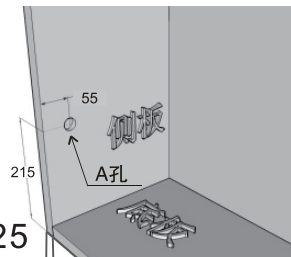

### 側板開孔 $\varnothing 25$

1. 在側板上按位置貼上治具
2. 按治具標示開孔 $\varnothing 25$ ，孔深 15mm

4

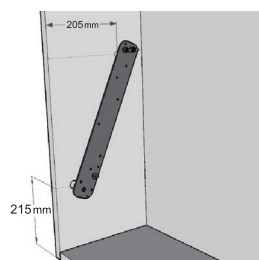

### 鋼板定位

1. 鋼板置入 $\varnothing 25$ 孔
2. 鋼板和治具相對應位置重疊
3. 用M5X20自攻螺絲固定

5

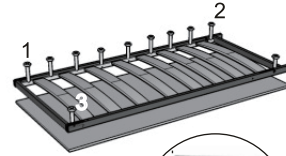

### 面板安裝

1. 面板前端如圖與床架平齊。
2. 面板左右兩側請與床架置中。
3. 先旋轉1.2.3.4四角各一顆螺絲。
4. 其他螺絲，待把左右門縫調解均勻在固定。

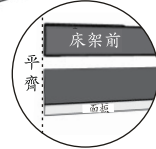

6

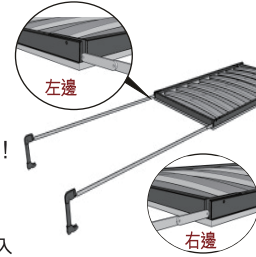

**注意左右腳之分！**

### 腳座安裝

1. 從床架前端鋼管插口插入
2. 短端在左側是左腳【如圖示】
3. 短端在右側是右腳【如圖示】

7



### 腳座安裝說明

床腳前端用M6X30三級螺絲鎖緊，螺母與螺絲平齊即可

8

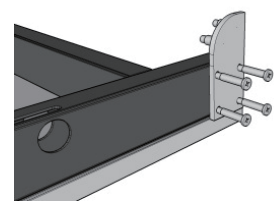

### 氣壓桿支撐架安裝

1. 將有四個螺絲孔的黑色塑膠，放入鋼管
2. 【如圖】使用四個螺絲，安裝氣壓桿支撐架

9

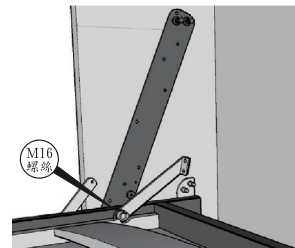

### 床架安裝

1. 將床架由櫃體底部放入
2. M16螺絲套上拉鐵件，對準鋼板孔旋緊【如圖所示】

10

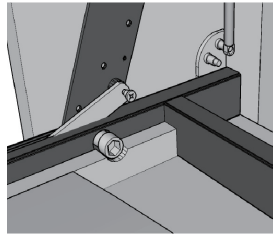

### 腳後端螺絲安裝

M6X15的三級螺絲安裝

14

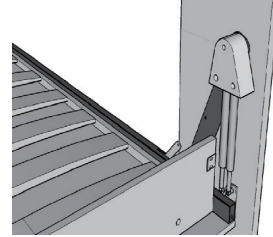

### 氣壓桿修飾蓋安裝

用自攻螺絲固定在鋼板上

11

❗ 氣壓桿未安裝好前  
不可拆掉鋼套！

### 氣壓桿安裝

1. 氣壓桿活動部分朝下裝在床架上
2. 另一端安裝在鋼板上，旋緊自鎖螺母
3. 床架往下壓，取出緊固套
4. 重複上述步驟，安裝其他氣壓桿

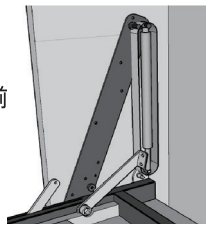

15

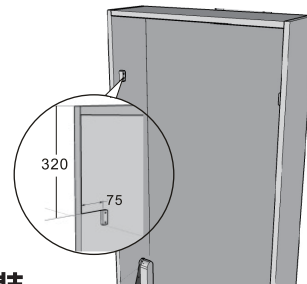

### 限位檔塊安裝

12A



### 床墊擋把手 83019900

如不需加裝檔板，也可以加裝把手作為參考，可以防止床墊下滑。

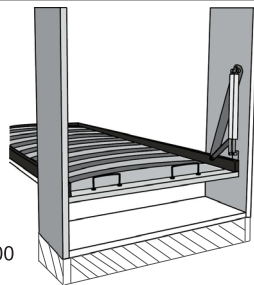

16



### 安裝床墊綁帶

安裝在面板的背面【如圖所示】

12B

❗ 此【床墊檔板】  
可依客戶需求  
加裝或不裝！

### 床墊檔板安裝

用家具螺絲安裝(200mm)

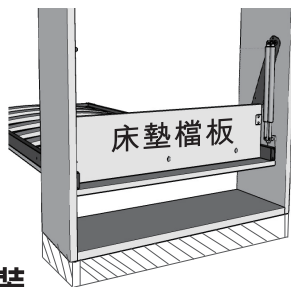

13

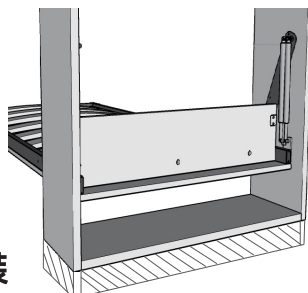

### 拉鐵件安裝

用M6X30內六角螺絲固定【如箭頭所示處】

完成17

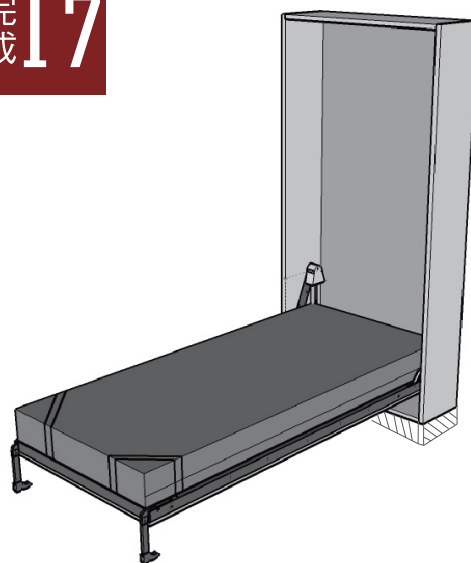

### 安裝完成效果圖

# 單人立式櫥櫃側掀床 加書桌 安裝說明

替換原配M6X13螺絲



調節六方柱，可以調節桌面水平度

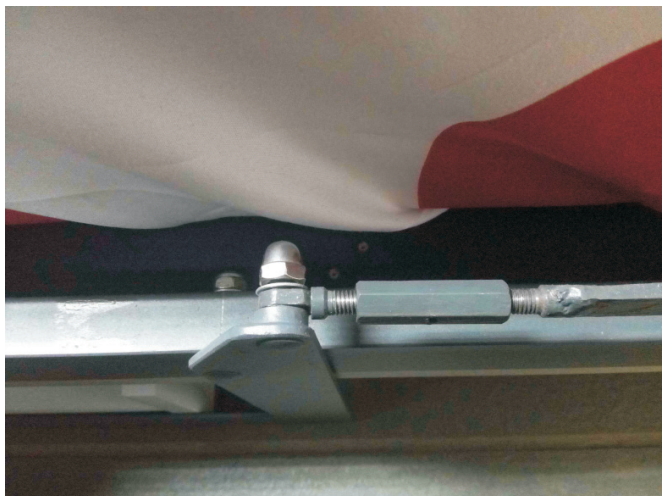

翻床-門檔



翻床-門檔

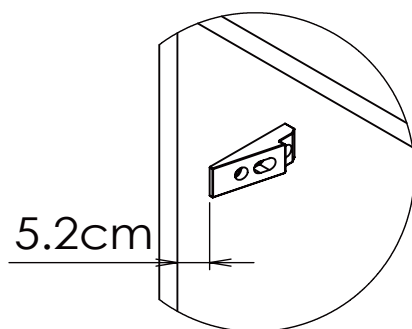

細部放大圖 A

注意事項:

- 1、安裝無腳書桌，要求翻床總體安裝安裝完畢後，調整好四周間隙均勻，兩側面間隙為7毫米，上下縫隙一致。
- 2、安裝緩衝導向型限位器。可有效保障兩側間隙均勻。
- 3、安裝無腳書桌連桿部分，調節螺栓應在外方向(靠近七字件)。

※以實際狀況，移動擋止位子※





## 配件:

- 1、L型支架-----2件(左右件)
- 2、連桿-----2件
- 3、自鎖螺母-----1包





- 1、在正翻床架的左、右側方通，從鋼架尾端向床腳方向量895mm(包括尾端塑料3mm)。距離方通上邊10mm處，鑽8mm通孔。
- 2、分好L型支架左右件，將支架8X35螺絲插入方通孔中，使用自鎖螺母固定。
- 3、將配件包中M6X226螺絲替換配床腳連桿上的M6X13。將連桿與腳連桿重疊穿入，擰緊。
- 4、將連桿有調節螺桿的一端連接在L型支架上，使用半圓頭螺帽固定，通過調整連接螺桿得旋轉長度，來調節桌面的水平面度。



## 翻床配件明細

編號	施工區域	名稱	型號	單位	數量	附圖
1	床架	平頭自攻螺絲	M4×45	顆	38	
2		轉軸螺絲	M16×45	顆	2	
3		彈簧墊片	M16	顆	2	
4		小鐵片(分左右)		件	2	
5		內六角平頭螺絲	M6×20	顆	8	
6		塑件四方塊		件	2	
7		鬆緊帶		件	2	
8	床框	L片		件	2	
9		內六角平頭螺絲	M8×40	顆	2	
10		膨脹螺絲	M8×80	顆	2	
		大鐵板(分左右)		塊	2	
11		限位檔塊		件	2	
12	大鐵板固定	內六角平頭螺絲	M6×30	顆	8	
13		平頭自攻螺絲	M5×20	顆	24	
14		自鎖螺帽	M8	顆	10	
15		裝飾蓋		件	2	
16		平頭自攻螺絲	M4×30	顆	10	
17	連桿固定	內六角扁頭螺絲	M6×15.5	顆	2	
18	床腳固定	內六角平頭螺絲	M6×33	顆	2	
19		螺帽	M6	顆	2	

# 翻床配件明細

編號	施工區域	名稱	型號	單位	數量	附圖
20	床頭檔板	大扁頭螺絲	M6×40	顆	4	
21		大扁頭內六角螺母	M6	顆	4	
22		床頭拉鐵		件	2	
23		內六角平頭螺絲	M6×25	顆	4	
24		內六角扳手	M6	把	1	
25		內六角扳手	M16	把	1	
26		氣壓桿	正單	件	4	
			正雙	件	4	
			側單	件	4	
			側雙	件	4	
27		床框開板圖面		套	1	
28		產品安裝說明書		張	1	

