

LAMP® LDD-S® Lapcon Door Damper (Surface mounted) Installation instructions



Read this manual thoroughly for proper and safe installation. Please retain this manual for future reference.

- Sugatsune's warranty is for the product itself and does not extend to the installation as a whole. In case of failure, Sugatsune's liability is limited to the replacement of the products by a similar one.
- The company is conducting strict check on the products, however, if any defects are found on the product, contact retailer.
- The warranty period is one year after the day of shipment. The company's responsibility shall be limited to replacement of the product.

Installation and usage notices

- This product is for indoor use only. Do not use in locations where it is in direct contact with water.
- This damper effectiveness maybe lessened when use in an environment subject to strong drafts.
- This damper may not be able to slow down the door if it is closed with excessive force.
- Despite extensive in-house testing, we recommend that you test your installation for proper interaction between the hinge and the LDD damper.
- The LDD may not pull the door completely closed when using an overly hard latch.
- Standard temperature of use is 0 to 40 °C.

Installation

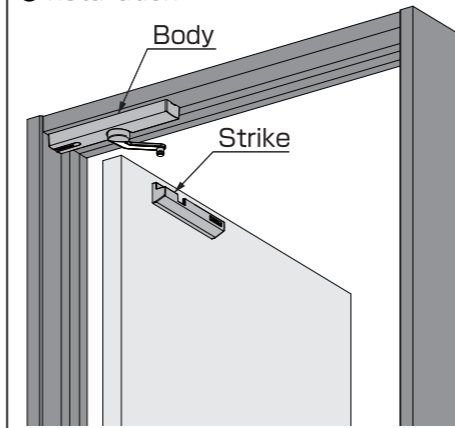

This drawing shows a right-hand opening type (LDD-S-R). Left-hand opening type (LDD-S-L) is symmetrically opposed.

Product functions and features

- This product is a SURFACE MOUNT TYPE door closer damper intended to be applied on the head frame.
- The damper function reduces door slamming sounds and the door begins to close slowly just before the complete closing and closes completely.
- Quick and easy to install. Just mount it close to the vertical frame and door stop. (*Depends on the frame width.)
- Featured with the function of door-closing power adjustment.
- The strike plate is featured with vertical/horizontal adjustment functions.

Parts list

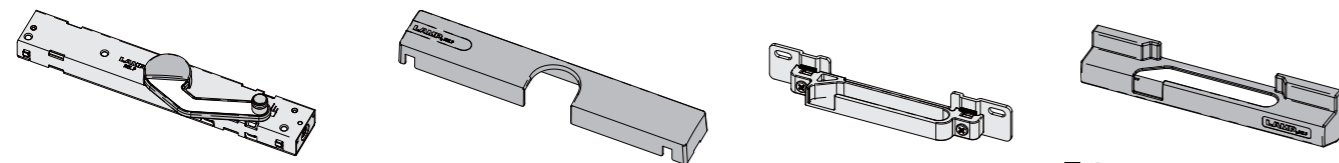

- *LDD-S body : 1 pcs
- *Body cover : 1 pcs
- *Strike plate unit : 1 pcs
- *Strike plate cover : 1 pcs

*RIGHT HAND TYPE (LDD-S-R) SHOWN. LEFT HAND TYPE (LDD-S-L) SYMMETRICALLY OPPOSITE.



- Body installation screw : 2pcs (nominal 3.5×30)
- Strike plate installation screw : 2pcs (nominal 4×16)
- Template for strike plate : 1pc
- Instruction Manual (this manual) : 1

Checking before the installation

- Check you door opening side
 - If the hinges are on your right when pulling the door open, choose the "Right-hand" opening type.
 - If the hinges are on your left when pulling the door open, choose the "Left-hand" opening type.

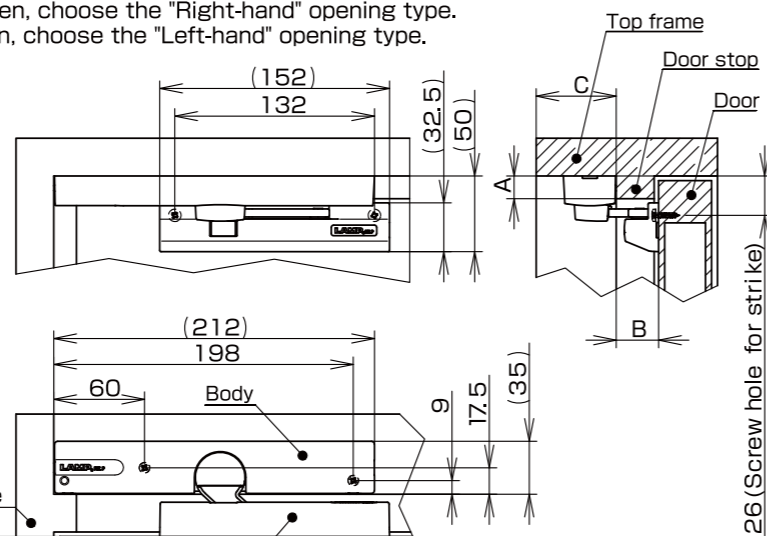
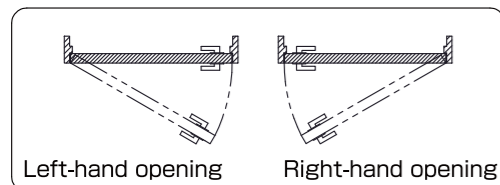

Unit : mm

Installation drawing

(This drawing shows a right-hand opening type (LDD-S-R). Left-hand opening type (LDD-S-L) is symmetrically opposed.)

Installation

⚠ Install and fully adjust the door, hinges and frame before installing the LDD-S

1.Main unit installation procedure

Mounting position and installation screw holes depend on the top frame mounting width C

• If C is 25 mm or more:

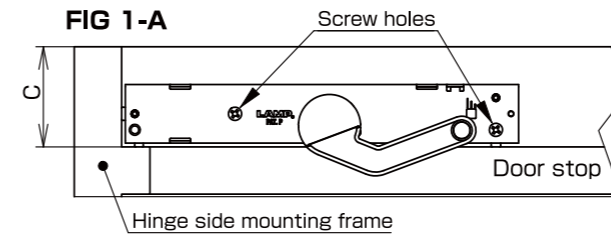

FIG 1-A : Line up the LDD-S body with the top door stop and hinge side mounting frame. Fix the body with the provided body installation screws.

• If C is between 20 mm and 25 mm / If Pivot hinge is used:

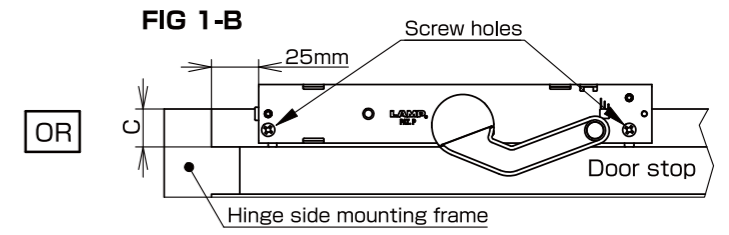
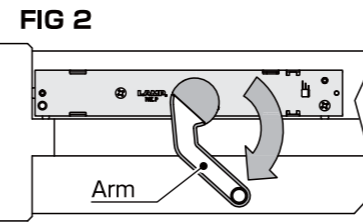

FIG 1-B : Line up the LDD-S body with the top door stop and 25mm away from the hinge side mounting frame. Fix the body with the provided body installation screws.

2.Strike plate installation procedure



- FIG 2-3 : ① Pull the Arm out completely. Do not put vertical force to the Arm.
 ② Close the door slowly while holding the arm fully open and place the template so that the arm roller fits in the square hole.
 ③ Adjust the template so that it is parallel with the top of the door and mark the screw hole shown on the template.

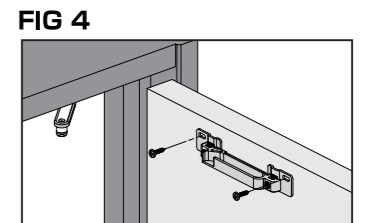
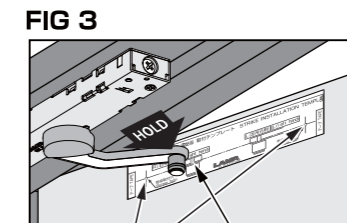
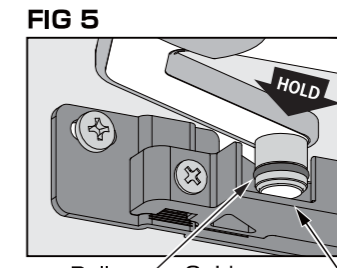
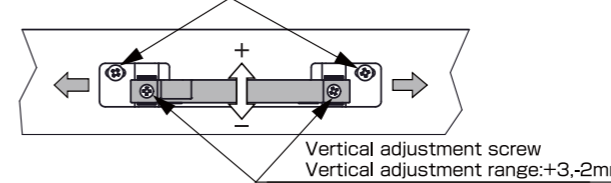

FIG 4 : Fix the strike plate with the installation screws provided.

3.Adjustments

- FIG 5-6: Confirm the Arm is completely pulled out. Close the door slowly while holding the arm fully open and check the Roller enters into the guide groove. If necessary, carry out vertical and/or horizontal adjustments to the strike plate. (See below.)
 ※Be sure to keep the Arm position.

Horizontal adjustment screw
 Horizontal adjustment range: ±3mm



Loosen adjustment screw, adjust strike plate position and re-tighten screw. Check roller position and adjust further if necessary. When adjustment is completed, open and close the door several times in order to check proper function of the LDD-S.

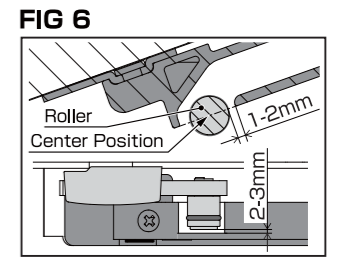

•Closing power adjustment

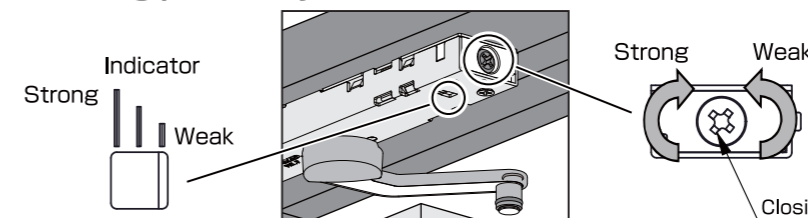

Closing power of the door can be adjusted by turning the Closing power adjustment screw. This only changes the final closing power, not the damping force of the LDD-S.

4.Attaching the covers

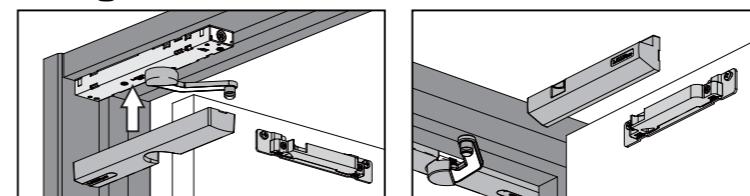

Attach the covers for the main unit and the strike plate while keeping the door open.

SUGATSUNE KOGYO CO.,LTD
 Tokyo, JAPAN
 Phone: +81 (0)3 3866 2260 E-mail:export@sugatsune.co.jp

SUGATSUNE KOGYO (UK) LTD
 Reading, UK
 Phone: +44 118 9272 955 E-mail:sales@sugatsune.co.uk

SUGATSUNE EUROPE GmbH
 Düsseldorf, GERMANY
 Phone: +49 211 53812900 E-mail:sales@sugatsune.eu

SUGATSUNE SHANGHAI Co., LTD
 Shanghai, CHINA
 Phone: +86 21 3632 1858 E-mail:lamp@sugatsune.com.cn

Guangzhou, CHINA
 Phone: +86 20 6639 3552 E-mail:lamp@sugatsune.com.cn

SUGATSUNE KOGYO INDIA PRIVATE LIMITED
 Mumbai, INDIA
 Phone: +91 22 28314490/91 E-mail:sales@sugatsune.in

SUGATSUNE AMERICA, INC
 California, USA
 Phone: +1 310 329 6373 E-mail:sales@sugatsune.com

Chicago, USA
 Phone: +1 312 461 1081 E-mail:chicagoshowroom@sugatsune.com.

SUGATSUNE CANADA, INC.
 Phone: +1 514 312 5267 E-mail:support@sugatsune.ca