

# 九宏五金

## 單人立式櫥櫃側掀床

### 安裝說明書



1. 櫃體四邊厚18mm也可。

2. 踢腳板高10cm也適用。

Ps. 餘尺寸亦可安裝，置位需自行運算。

此份為最新掀床說明書！共7張

客戶簽收：

# 物美單人側掀床五金尺寸

## 物美單人側掀床五金尺寸+書桌

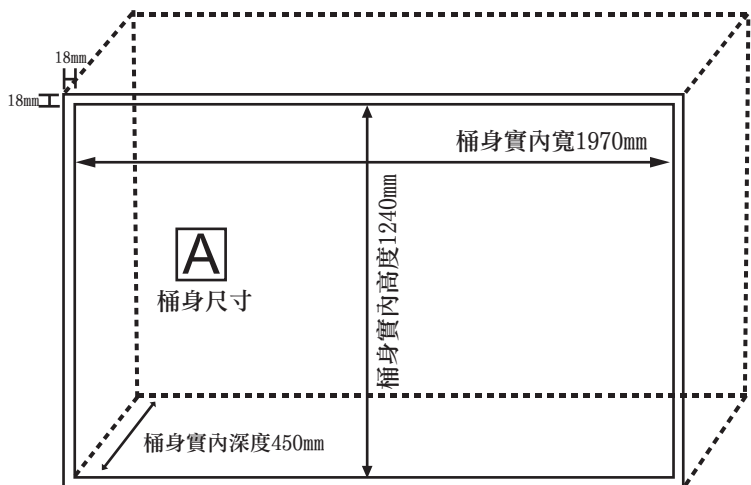

桶身實內

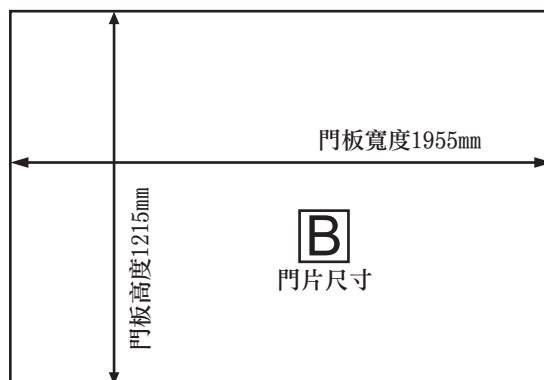

床架門板

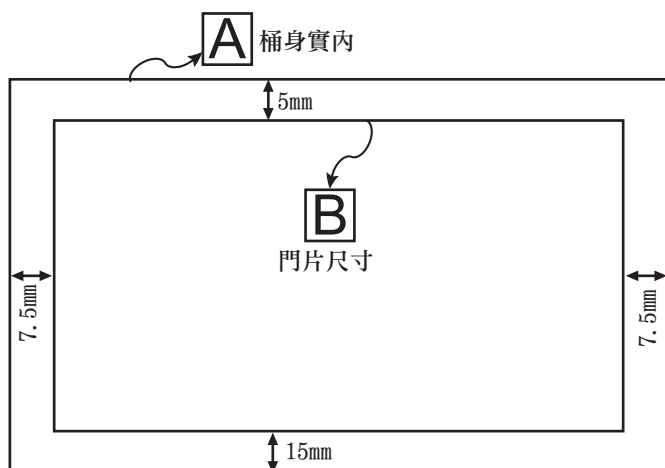

桶身與門板的縫隙

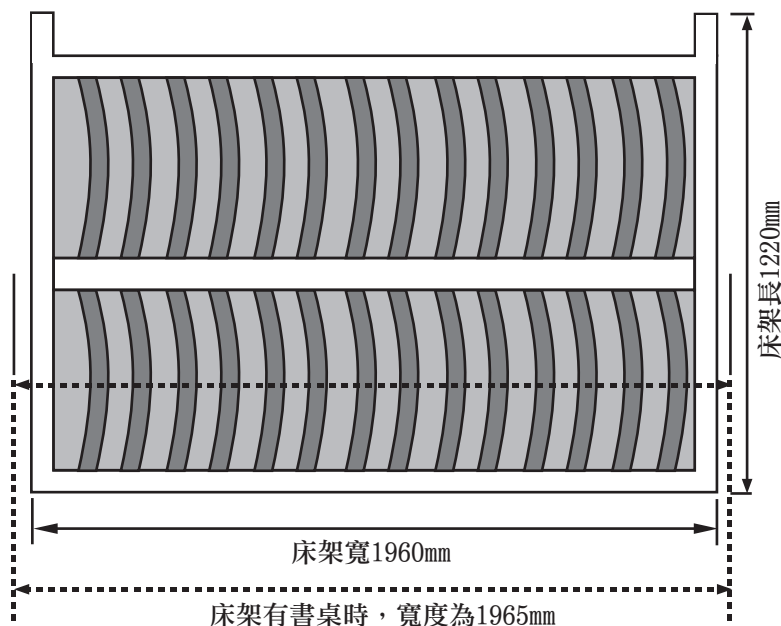

床墊尺寸: 1090 (3.5尺) X 1900 (6.2尺)

床墊重量 (無桌板): 45KG <sup>+0kg</sup> <sub>-1kg</sub>

床墊重量 (有桌板): 25KG <sup>+0kg</sup> <sub>-1kg</sub>

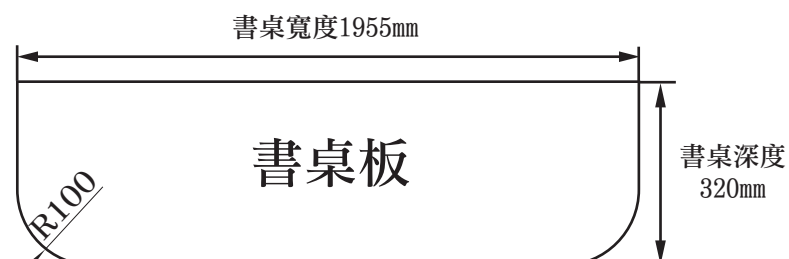
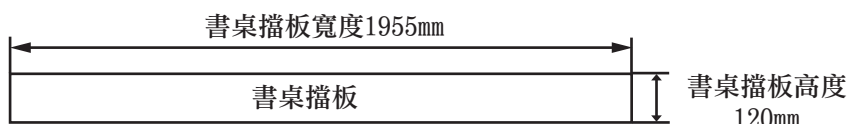

# 依客戶需求二擇一安裝床墊擋

## 側掀單人 床墊擋板

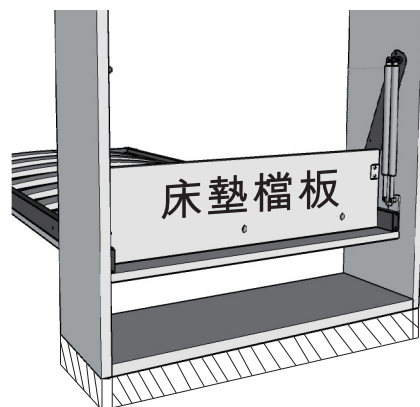

(此五金有安裝床墊擋板再安裝即可)

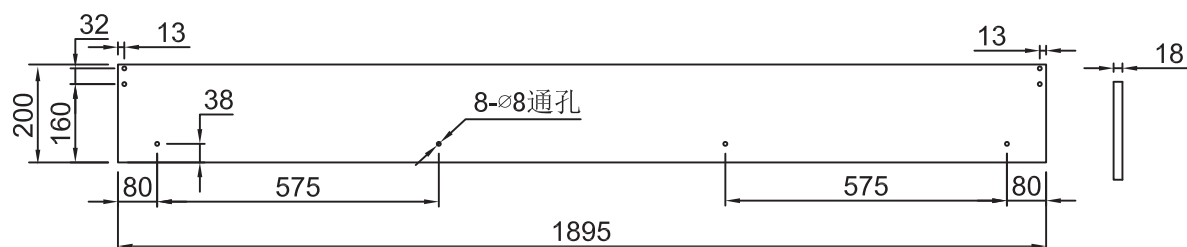

## 床墊檔把手 (亦可用)

鎖至床架上 (使用自攻螺絲)

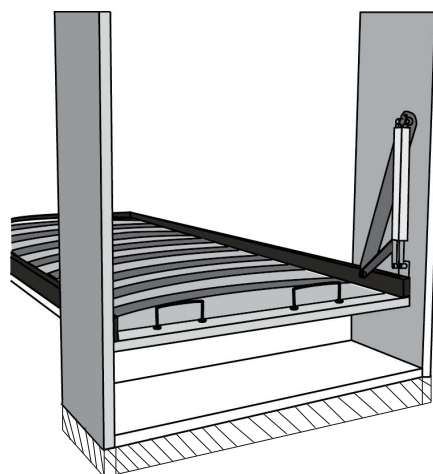



**1**

**櫃體安裝**  
保證櫃體對角線A-A和B-B相等

**2 非常重要**

**櫃體固定**  
用膨脹螺絲和L片將櫃體固定在牆上  
如圖：A 向膨脹螺絲 B 向M8X40螺絲

**3**

**側板開孔 $\varnothing$ 25**  
1. 在側板上按位置貼上治具  
2. 按治具標示開孔 $\varnothing$ 25，孔深 15mm

**4**

**鋼板定位**  
1. 鋼板置入 $\varnothing$ 25孔  
2. 鋼板和治具相對應位置重疊  
3. 用12X8MM螺母引孔後固定。

**5**

**面板安裝**  
1. 面板前端如圖與床架平齊。  
2. 面板左右兩側請與床架置中。  
3. 先旋轉1.2.3.4四角各一顆螺絲。  
4. 再8MM引孔將螺母固定至面板後，再將床架固定。

**6**

**腳座安裝**  
注意左右腳之分！  
1. 從床架前端鋼管插口插入  
2. 短端在左側是左腳【如圖示】  
3. 短端在右側是右腳【如圖示】

**7**

**腳座安裝說明**  
床腳前端用M6X30三級螺絲鎖緊，螺母與螺絲平齊即可

**8**

**氣壓桿支撐架安裝**  
1. 將有四個螺絲孔的黑色塑膠，放入鋼管  
2. 【如圖】使用四個螺絲，安裝氣壓桿支撐架

**9**

**床架安裝**  
1. 將床架由櫃體底部放入  
2. M16螺絲套上拉鐵件，對準鋼板孔旋緊【如圖所示】

**10**

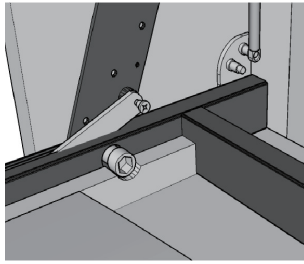

**腳後端螺絲安裝**  
M6X15的三級螺絲安裝

**14**

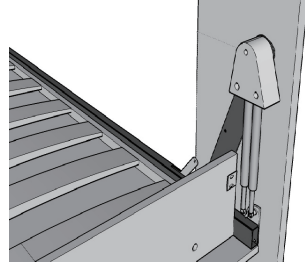

**氣壓桿修飾蓋安裝**  
用自攻螺絲固定在鋼板上

**11**

**!** 氣壓桿未安裝好前  
不可拆掉鋼套！

**氣壓桿安裝**

1. 氣壓桿活動部分朝下裝在床架上
2. 另一端安裝在鋼板上，旋緊自鎖螺母
3. 床架往下壓，取出緊固套
4. 重複上述步驟，安裝其他氣壓桿



**15**

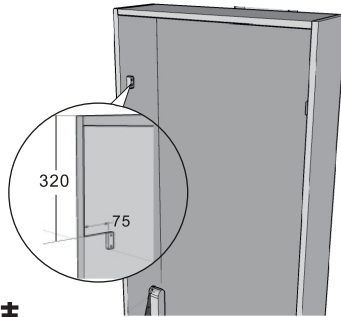

**限位檔塊安裝**

**12A**

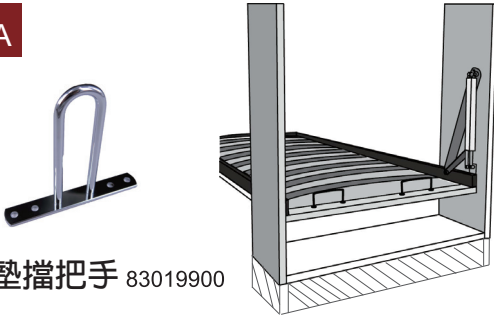

**床墊擋把手 83019900**

如不需加裝檔板，也可以加裝把手作為參考，可以防止床墊下滑。

**16**



**安裝床墊綁帶**  
安裝在面板的背面【如圖所示】

**12B**

**!** 此【床墊檔板】  
可依客戶需求  
加裝或不裝！

**床墊檔板安裝**  
用家具螺絲安裝(200mm)

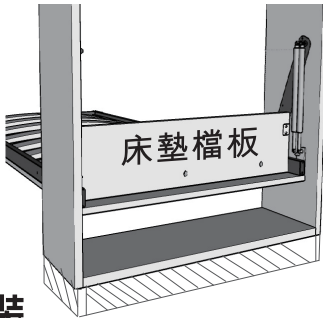

**13**

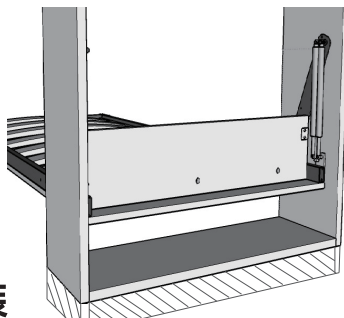

**拉鐵件安裝**  
用M6X30內六角螺絲固定【如箭頭所示處】

**完成 17**

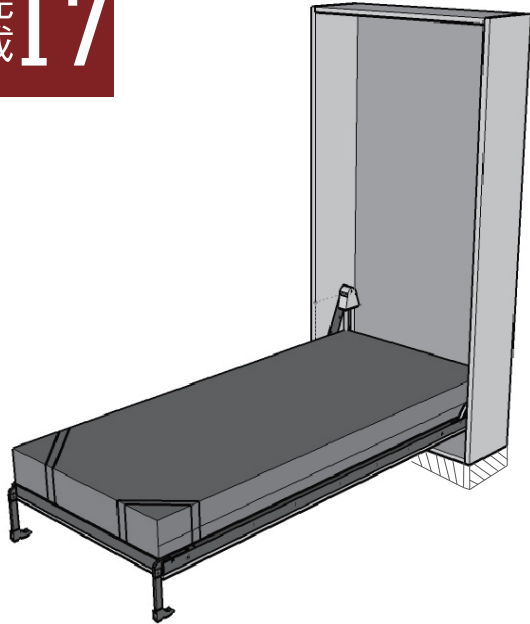



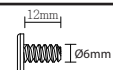

**安裝完成效果圖**

# 翻床配件明細

編號	施工區域	名稱	型號	單位	數量	附圖
1	床架	床架用螺絲	40X6	顆	52	
2		轉軸螺絲	M16×45	顆	2	
3		彈簧墊片	M16	顆	2	
4		小鐵片(分左右)		件	2	
5		內六角平頭螺絲	M6×20	顆	8	
6		塑件四方塊		件	2	
7		鬆緊帶		件	2	
8	床框	L片		件	2	
9		內六角平頭螺絲	M8×40	顆	2	
10		膨脹螺絲	M8×80	顆	2	
		大鐵板(分左右)		塊	2	
11		限位檔塊		件	2	
12	大鐵板固定	內六角平頭螺絲	M6×30	顆	8	
13		側板用螺絲	M5×20	顆	14	
14		螺絲螺母	13X8	顆	66	
15		自鎖螺帽	M8	顆	10	
16		裝飾蓋		件	2	
17	連桿固定	內六角扁頭螺絲	M6×15.5	顆	2	
18	床腳固定	內六角平頭螺絲	M6×33	顆	2	
19		螺帽	M6	顆	2	

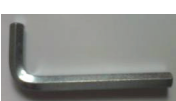
# 翻床配件明細

編號	施工區域	名稱	型號	單位	數量	附圖
20	床頭檔板	大扁頭螺絲	M6×40	顆	4	
21		大扁頭內六角螺母	M6	顆	4	
22		床頭拉鐵		件	2	
23		內六角平頭螺絲	M6×25	顆	4	
24		內六角板手	M6	把	1	
25		內六角板手	M16	把	1	
26		氣壓桿	正單	件	4	
			正雙	件	4	
			側單	件	4	
			側雙	件	4	
27		床框開板圖面		套	1	
28		產品安裝說明書		張	1	

