

九宏五金

單人立式櫥櫃正掀床 加書桌

安裝說明書



1. 櫃體四邊厚18mm也可。

2. 踢腳板高10cm也適用。

Ps. 餘尺寸亦可安裝，置位需自行運算。

此份為最新掀床說明書！共10張

客戶簽收：

物美單人正掀床五金尺寸

物美單人正掀床五金尺寸+書桌

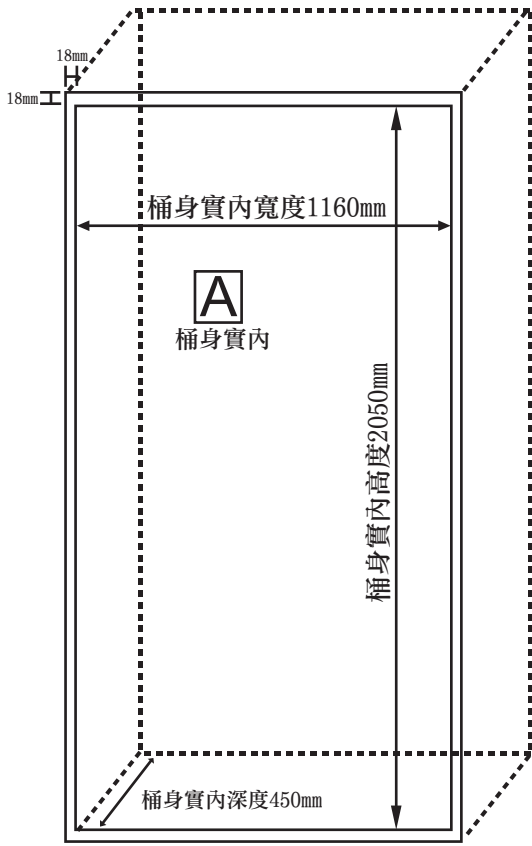

桶身實內

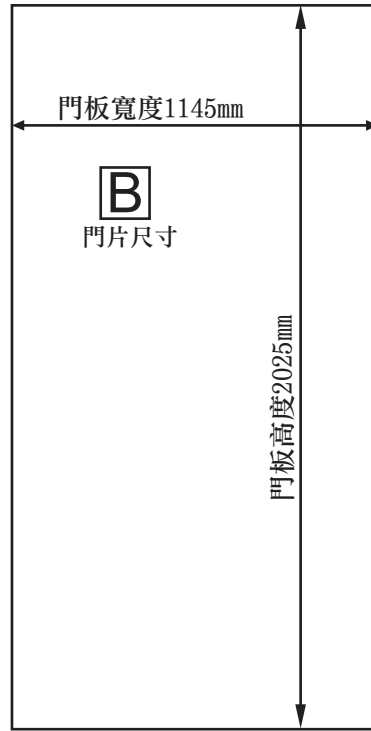

床架門板

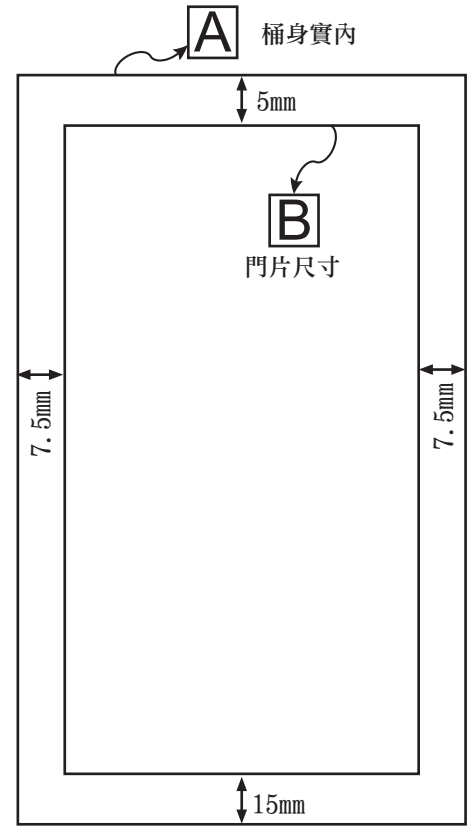

桶身與門板的縫隙

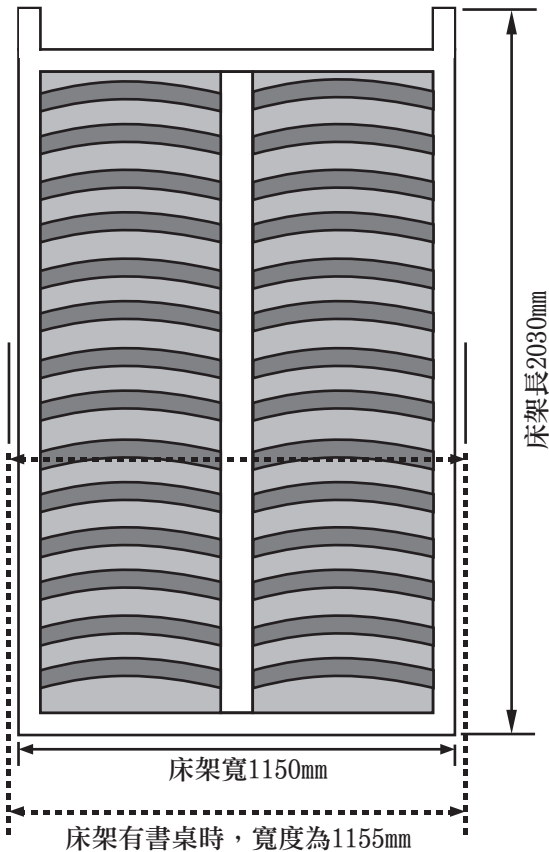

床架

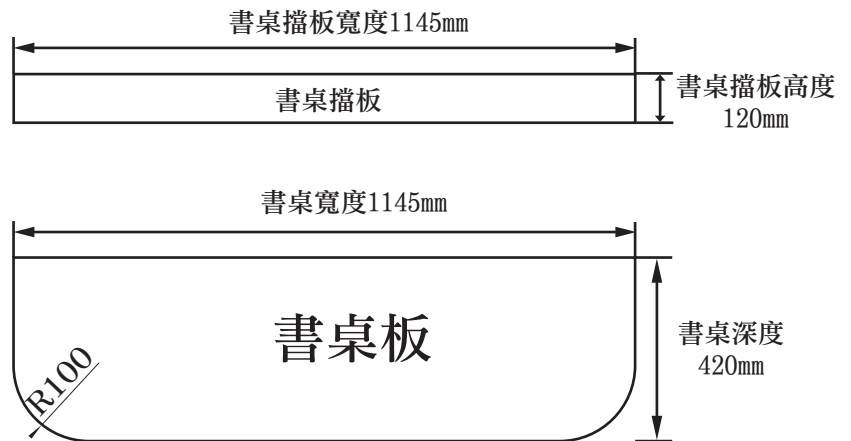

床墊尺寸: 1090 (3.5尺) X 1900 (6.2尺)

床墊重量 (無桌板): 30KG^{+0kg}_{-1kg}

床墊重量 (有桌板): 25KG^{+0kg}_{-1kg}

依客戶需求二擇一安裝床墊擋

正掀單人 床墊擋板

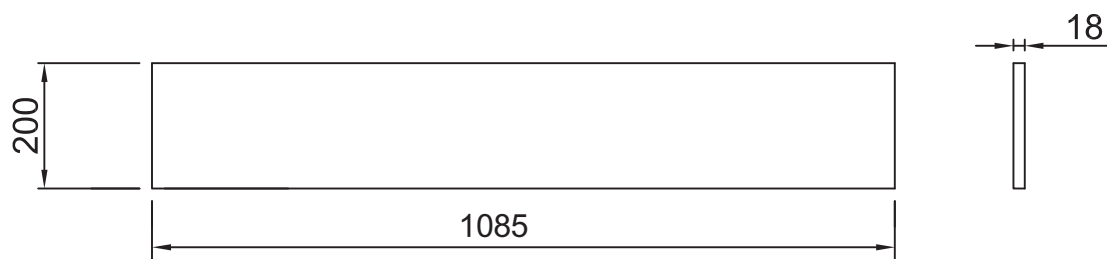
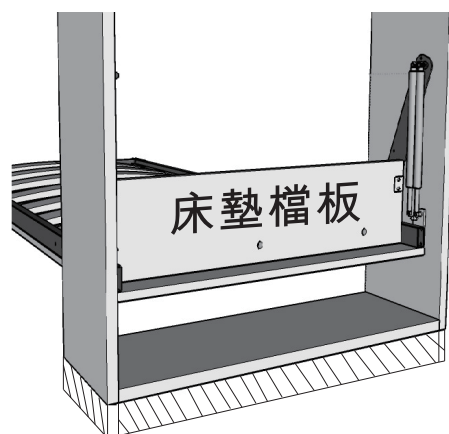

床墊擋把手 (亦可用)

鎖至床架上(使用自攻螺絲)

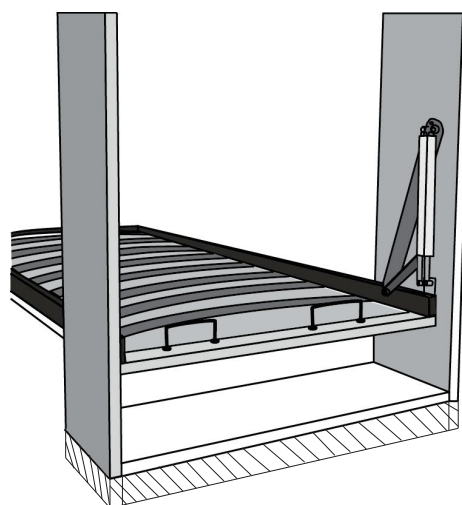

立式櫥櫃書桌正翻床五金 安裝說明

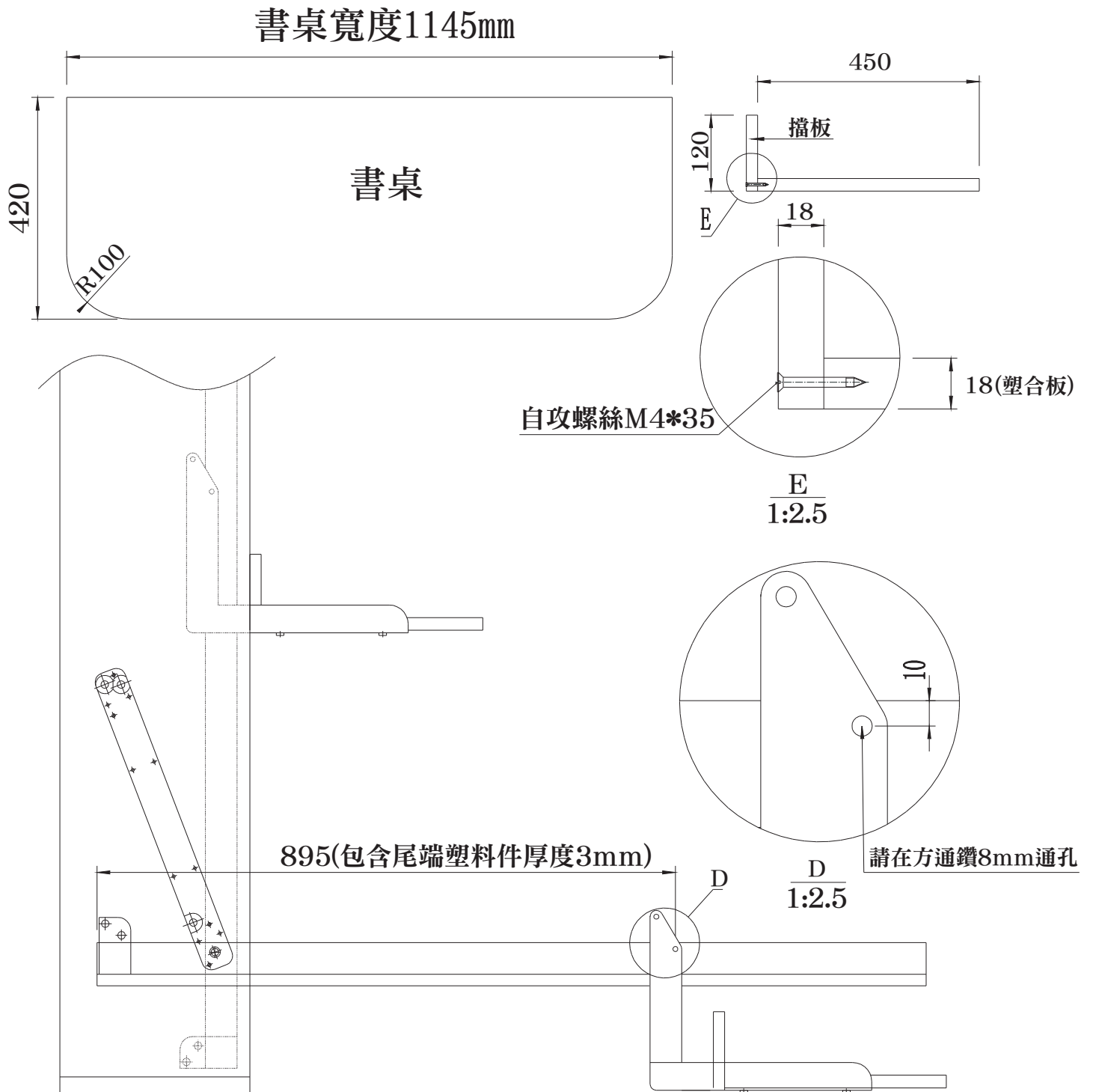

1

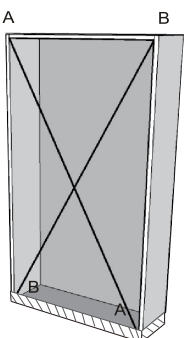

櫃體安裝
保證櫃體對角線A-A和B-B相等

2 非常重要

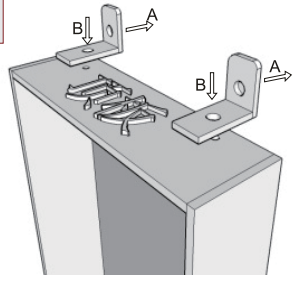

櫃體固定
用膨脹螺絲和L片將櫃體固定在牆上
如圖：A向膨脹螺絲 B向M8X40螺絲

3

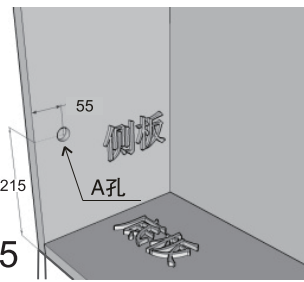

側板開孔 $\varnothing 25$
1. 在側板上按位置貼上治具
2. 按治具標示開孔 $\varnothing 25$ ，孔深 15mm

4

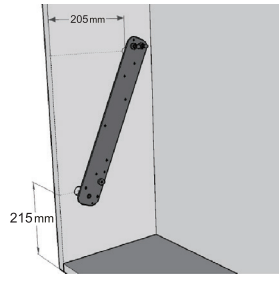

鋼板定位
1. 鋼板置入 $\varnothing 25$ 孔
2. 鋼板和治具相對應位置重疊
3. 用M5X20自攻螺絲固定

5

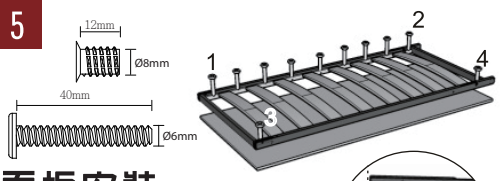

面板安裝
1. 面板前端如圖與床架平齊。
2. 面板左右兩側請與床架置中。
3. 先旋轉1.2.3.4四角各一顆螺絲。
4. 再8MM引孔將螺母固定至面板後，再將床架固定。

6

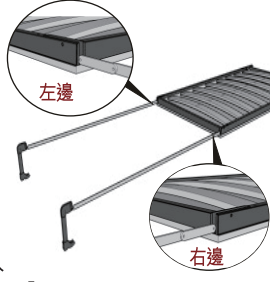

腳座安裝
1. 從床架前端鋼管插口插入
2. 短端在左側是左腳【如圖示】
3. 短端在右側是右腳【如圖示】

7



腳座安裝說明
床腳前端用M6X30三級螺絲鎖緊，螺母與螺絲平齊即可

8

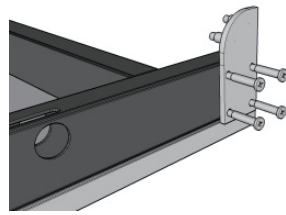

氣壓桿支撐架安裝
1. 將有四個螺絲孔的黑色塑膠，放入鋼管
2. 【如圖】使用四個螺絲，安裝氣壓桿支撐架

9

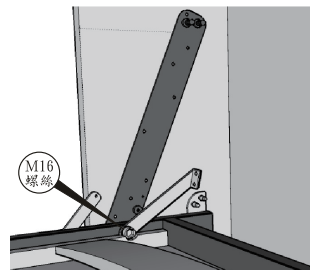

床架安裝
1. 將床架由櫃體底部放入
2. M16螺絲套上拉鐵件，對準鋼板孔旋緊【如圖所示】

10

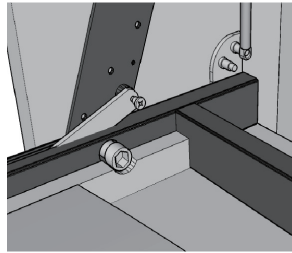

腳後端螺絲安裝

M6X15的三級螺絲安裝

14

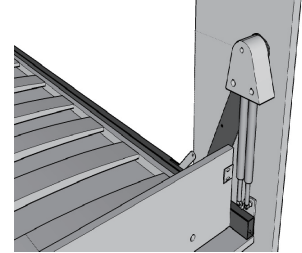

氣壓桿修飾蓋安裝

用自攻螺絲固定在鋼板上

11

❗ 氣壓桿未安裝好前
不可拆掉鋼套！

氣壓桿安裝

1. 氣壓桿活動部分朝下裝在床架上
2. 另一端安裝在鋼板上，旋緊自鎖螺母
3. 床架往下壓，取出緊固套
4. 重複上述步驟，安裝其他氣壓桿

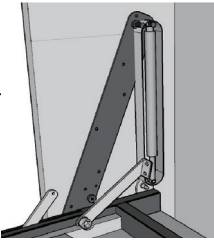

15

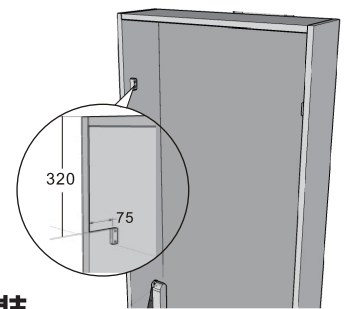

限位檔塊安裝

12 A



床墊擋把手 83019900

如不需加裝檔板，也可以加裝把手作為參考，可以防止床墊下滑。

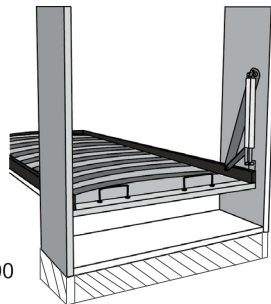

16



安裝床墊綁帶

安裝在面板的背面【如圖所示】

12 B

❗ 此【床墊檔板】
可依客戶需求
加裝或不裝！

床墊檔板安裝

用家具螺絲安裝(200mm)

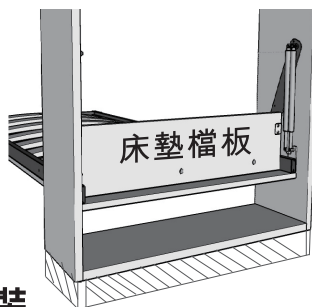

13

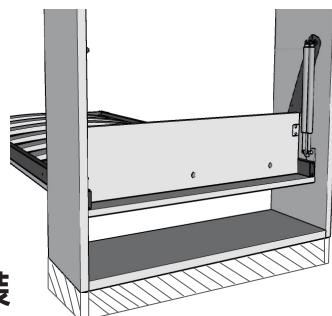

拉鐵件安裝

用M6X30內六角螺絲固定【如箭頭所示處】

完成 17

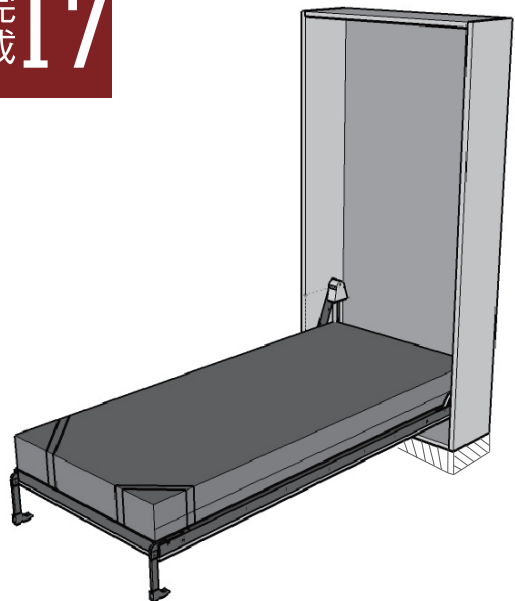

安裝完成效果圖

立式櫥櫃書桌正翻床五金 安裝說明

替換原配M6X13螺絲



調節六方柱，可以調節桌面水平度

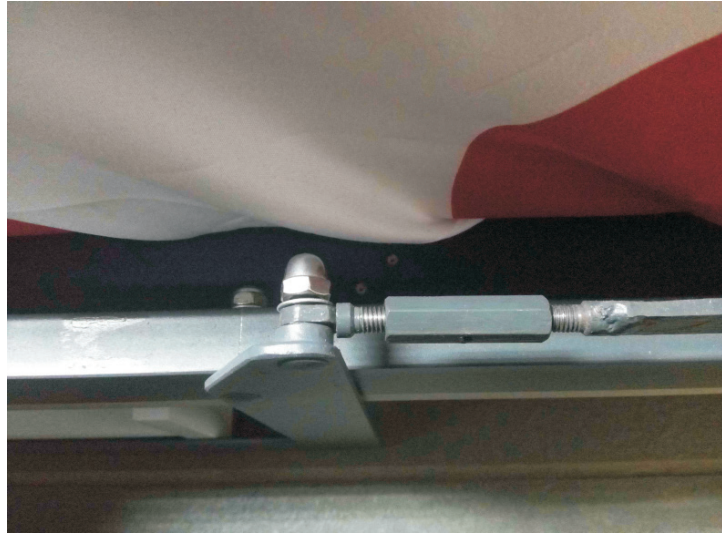

翻床-門檔



翻床-門檔

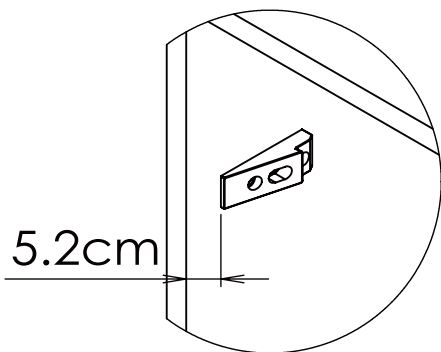

細部放大圖 A

注意事項:

- 1、安裝無腳書桌，要求翻床總體安裝完畢後，調整好四周間隙均勻，兩側面間隙為7毫米，上下縫隙一致。
- 2、安裝緩衝導向型限位器。可有效保障兩側間隙均勻。
- 3、安裝無腳書桌連桿部分，調節螺栓應在外方向(靠近七字件)。

※以實際狀況，移動擋止位子※









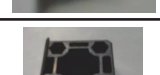

配件:

- 1、L型支架-----2件(左右件)
- 2、連桿-----2件
- 3、自鎖螺母-----1包







安裝步驟:

- 1、在正翻床架的左、右側方通，從鋼架尾端向床腳方向量895mm(包括尾端塑料3mm)。距離方通上邊10mm處，鑽8mm通孔。
- 2、分好L型支架左右件，將支架8X35螺絲插入方通孔中，使用自鎖螺母固定。
- 3、將配件包中M6X226螺絲替換配床腳連桿上的M6X13。將連桿與腳連桿重疊穿入，擰緊。
- 4、將連桿有調節螺桿的一端連接在L型支架上，使用半圓頭螺帽固定，通過調整連接螺桿得旋轉長度，來調節桌面的水平面度。

翻床配件明細

| 編號 | 施工區域 | 名稱 | 型號 | 單位 | 數量 | 附圖 |
|----|-------|----------|---------|----|----|---|
| 1 | 床架 | 平頭自攻螺絲 | M4×45 | 顆 | 38 |  |
| 2 | | 轉軸螺絲 | M16×45 | 顆 | 2 |  |
| 3 | | 彈簧墊片 | M16 | 顆 | 2 |  |
| 4 | | 小鐵片(分左右) | | 件 | 2 |  |
| 5 | | 內六角平頭螺絲 | M6×20 | 顆 | 8 |  |
| 6 | | 塑件四方塊 | | 件 | 2 |  |
| 7 | | 鬆緊帶 | | 件 | 2 |  |
| 8 | 床框 | L片 | | 件 | 2 |  |
| 9 | | 內六角平頭螺絲 | M8×40 | 顆 | 2 |  |
| 10 | | 膨脹螺絲 | M8×80 | 顆 | 2 |  |
| | | 大鐵板(分左右) | | 塊 | 2 |  |
| 11 | | 限位檔塊 | | 件 | 2 |  |
| 12 | 大鐵板固定 | 內六角平頭螺絲 | M6×30 | 顆 | 8 |  |
| 13 | | 平頭自攻螺絲 | M5×20 | 顆 | 24 |  |
| 14 | | 自鎖螺帽 | M8 | 顆 | 10 |  |
| 15 | | 裝飾蓋 | | 件 | 2 |  |
| 16 | | 平頭自攻螺絲 | M4×30 | 顆 | 10 |  |
| 17 | 連桿固定 | 內六角扁頭螺絲 | M6×15.5 | 顆 | 2 |  |
| 18 | 床腳固定 | 內六角平頭螺絲 | M6×33 | 顆 | 2 |  |
| 19 | | 螺帽 | M6 | 顆 | 2 |  |

翻床配件明細

| 編號 | 施工區域 | 名稱 | 型號 | 單位 | 數量 | 附圖 |
|----|------|----------|-------|----|----|--|
| 20 | 床頭檔板 | 大扁頭螺絲 | M6×40 | 顆 | 4 |  |
| 21 | | 大扁頭內六角螺母 | M6 | 顆 | 4 |  |
| 22 | | 床頭拉鐵 | | 件 | 2 | |
| 23 | | 內六角平頭螺絲 | M6×25 | 顆 | 4 |  |
| 24 | | 內六角板手 | M6 | 把 | 1 |  |
| 25 | | 內六角板手 | M16 | 把 | 1 |  |
| 26 | | 氣壓桿 | 正單 | 件 | 4 |  |
| | | | 正雙 | 件 | 4 | |
| | | | 側單 | 件 | 4 | |
| | | | 側雙 | 件 | 4 | |
| 27 | | 床框開板圖面 | | 套 | 1 | |
| 28 | | 產品安裝說明書 | | 張 | 1 | |

